

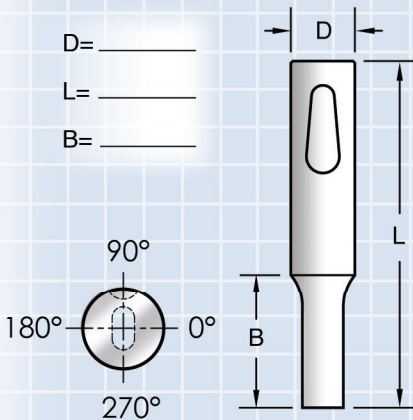

BALL LOCK

- Light Duty
- Heavy Duty
- Ejector



P= _____

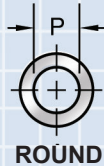

P= _____
W= _____



P= _____
W= _____

Optional R
**SQUARE or
RECTANGLE**

SHOULDER PUNCH

- Ejector
- Standard
- Diamond

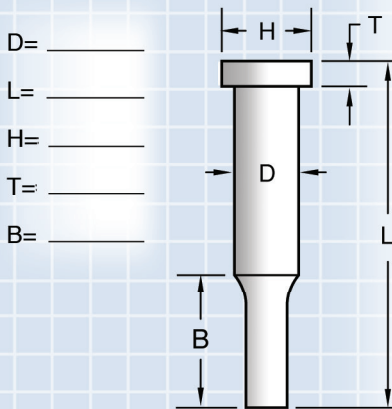

PRESS FIT BUTTON

BALL LOCK

- Standard
- Diamond

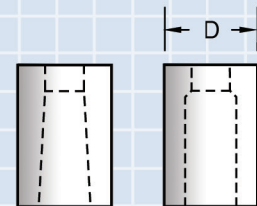
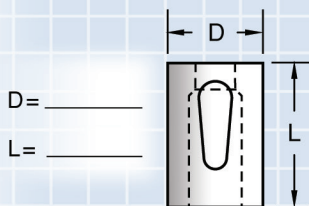

D= _____
L= _____
H= _____
T= _____
B= _____

SHOULDER BUTTON

- Standard
- Diamond

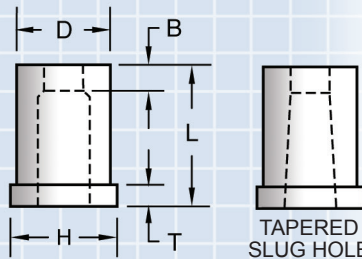

OPTIONS

See page 32-33 for locating flats and grooves.
See page 36-37 for classified shapes.

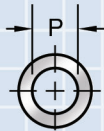

P= _____

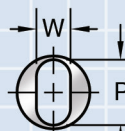

P= _____
W= _____

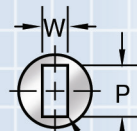

P= _____
W= _____